



**KD-3912**  
网篮 / Soap basket  
材质: SUS 304  
工艺: 亮光  
箱容: 40



**3900 series**

优雅风范 至尊气度  
Gentler demeanour  
imperial vigour



**KD-3908**  
衣钩 / Clothes hood  
材质: SUS 304  
工艺: 亮光  
箱容: 60



**KD-3915**  
皂碟 / Soap dish  
材质: SUS 304  
工艺: 亮光  
箱容: 40



**KD-3906**  
单杯 / Tumbler holder  
材质: SUS 304  
工艺: 亮光  
箱容: 40



**KD-3913**  
双杯架 / Double tumblers holder  
材质: SUS 304  
工艺: 亮光  
箱容: 40



**KD-3910**  
毛巾环 / Towel ring  
材质: SUS 304  
工艺: 亮光  
箱容: 40



**KD-3909**  
纸巾架 / Paper holder  
材质: SUS 304  
工艺: 亮光  
箱容: 40

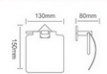





**KD-3905-1**

单层化妆台 / Glass shelf  
材质: SUS 304  
工艺: 亮光  
箱容: 15



**KD-3905-2**

单层化妆台 / Glass shelf  
材质: SUS 304  
工艺: 亮光  
箱容: 15



**KD-3903-1**

二层置物架  
Double layer glass shelf  
材质: SUS 304  
工艺: 亮光  
箱容: 10

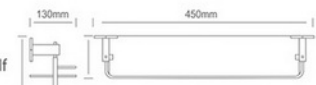

**KD-3903-2**

二层置物架  
Double layer glass shelf  
材质: SUS 304  
工艺: 亮光  
箱容: 10

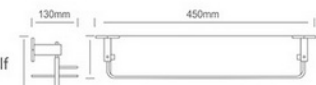

**KD-3911**

马桶刷 / Toilet brush  
材质: SUS 304  
工艺: 亮光  
箱容: 30

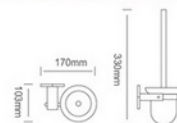

**KD-3902**

单杆 / Towel bar  
材质: SUS 304  
工艺: 亮光  
箱容: 40



**KD-3901**

双杆 / Double towel bar  
材质: SUS 304  
工艺: 亮光  
箱容: 30



## 3900 series

优雅风范 至尊气度  
Gentler demeanour  
imperial vigour



**KD-3900**

浴巾架 / Towel shelf  
材质: SUS 304  
工艺: 亮光  
箱容: 12







**KD-3808**  
 衣钩 / Clothes hood  
 材质: SUS 304  
 工艺: 亮光  
 箱容: 60

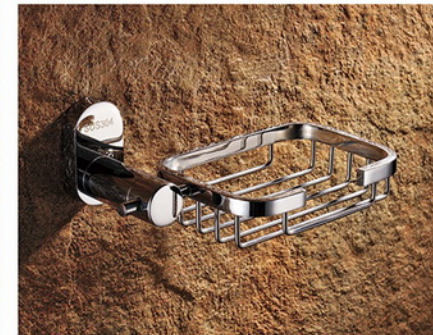

**KD-3812**  
 皂网 / Soap basket  
 材质: SUS 304  
 工艺: 亮光  
 箱容: 40

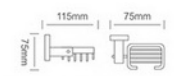

**KD-3806**  
 单杯 / Tumbler holder  
 材质: SUS 304  
 工艺: 亮光  
 箱容: 40

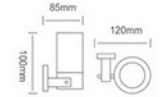

**KD-3815**  
 皂碟 / Soap dish  
 材质: SUS 304  
 工艺: 亮光  
 箱容: 40



**KD-3810**  
 毛巾环 / Towel ring  
 材质: SUS 304  
 工艺: 亮光  
 箱容: 40

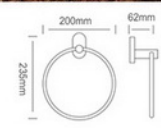

**KD-3809**  
 纸巾架 / Paper holder  
 材质: SUS 304  
 工艺: 亮光  
 箱容: 40

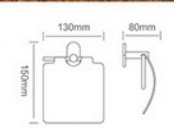

**KD-3813**  
 双杯架 / Double tumbler holder  
 材质: SUS 304  
 工艺: 亮光  
 箱容: 40



**3800 series**

时代韵味 艺术生活  
 Modern aroma  
 artistic life







**KD-3805-1**  
单层化妆台 / Glass shelf  
材质: SUS 304  
工艺: 亮光  
箱容: 15



**KD-3905-2**  
单层化妆台 / Glass shelf  
材质: SUS 304  
工艺: 亮光  
箱容: 15

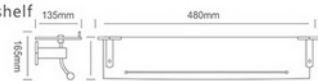

**KD-3803-1**  
二层置物架  
Double layer glass shelf  
材质: SUS 304  
工艺: 亮光  
箱容: 10

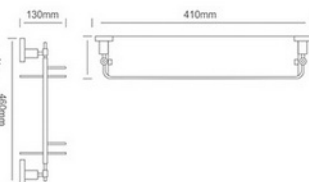

**KD-3803-2**  
二层置物架  
Double layer glass shelf  
材质: SUS 304  
工艺: 亮光  
箱容: 10

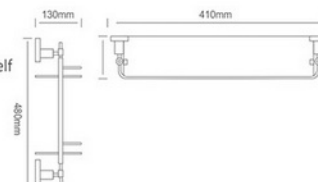

**KD-3811**  
马桶刷 / Toilet brush  
材质: SUS 304  
工艺: 亮光  
箱容: 30



**KD-3802**  
单杆 / Towel bar  
材质: SUS 304  
工艺: 亮光  
箱容: 40



**KD-3801**  
双杆 / Double towel bar  
材质: SUS 304  
工艺: 亮光  
箱容: 30



**KD-3816**  
高低杆 / Double towel bar  
材质: SUS 304  
工艺: 亮光  
箱容: 30



**KD-3800**  
浴巾架 / Towel shelf  
材质: SUS 304  
工艺: 亮光  
箱容: 12



## 3800 series

时代韵味 艺术生活  
Modern aroma  
artistic life





## 4500 series

古典雅致 浪漫情调  
Classicality and elegance  
romantic and sentiment



**KD-4508**  
衣钩 / Clothes hook  
材质: SUS 304  
工艺: 亮光  
箱容: 60



**KD-4512**  
皂网 / Soap dish  
材质: SUS 304  
工艺: 亮光  
箱容: 40



**KD-4506**  
单杯 / Tumbler holder  
材质: SUS 304  
工艺: 亮光  
箱容: 40



**KD-4513**  
双杯架 / Double tumbler holder  
材质: SUS 304  
工艺: 亮光  
箱容: 40



**KD-4515**  
皂碟 / Soap dish  
材质: SUS 304  
工艺: 亮光  
箱容: 40



**KD-4510**  
毛巾环 / Soap basket  
材质: SUS 304  
工艺: 亮光  
箱容: 40





**KD4505-1**

单层化妆台 / Glass shelf  
材质: SUS 304  
工艺: 亮光  
箱容: 15



**KD-4505-2**

单层化妆台 / Glass shelf  
材质: SUS 304  
工艺: 亮光  
箱容: 15

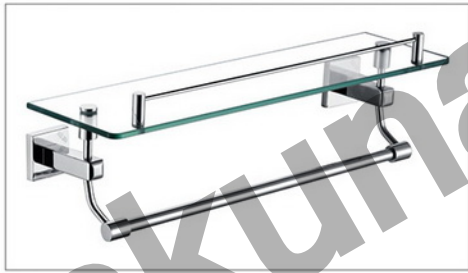

**KD-4503-1**

二层置物架  
Double layer glass shelf  
材质: SUS 304  
工艺: 亮光  
箱容: 10

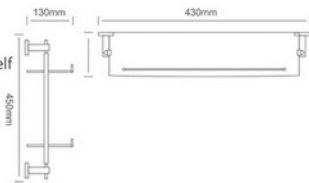

**KD-4503-2**

二层置物架  
Double layer glass shelf  
材质: SUS 304  
工艺: 亮光  
箱容: 10

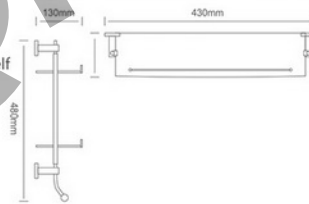

**KD-4511**

马桶刷 / Toilet brush  
材质: SUS 304  
工艺: 亮光  
箱容: 30



**KD-4502**

单杆 / Towel bar  
材质: SUS 304  
工艺: 亮光  
箱容: 40



**KD-4501**

双杆 / Double towel bar  
材质: SUS 304  
工艺: 亮光  
箱容: 30



## 4500 series

古典雅致 浪漫情调  
Classicality and elegance  
romantic and sentiment



**KD-4509**

纸巾架 / Paper holder  
材质: SUS 304  
工艺: 亮光  
箱容: 40

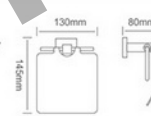

**KD-4500**

浴巾架 / Towel shelf  
材质: SUS 304  
工艺: 亮光  
箱容: 12

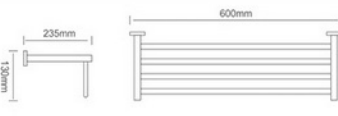





## 4300series

缤纷生活 情趣盎然  
In roitous profusion life  
exuberant sentiment



**KD-4308**  
衣钩 / Clothes hood  
材质: SUS 304  
工艺: 亮光  
箱容: 60



**KD-4312**  
皂网 / Soap dish  
材质: SUS 304  
工艺: 亮光  
箱容: 40

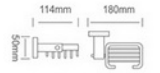

**KD-4306**  
单杯 / Tumbler holder  
材质: SUS 304  
工艺: 亮光  
箱容: 40



**KD-4313**  
双杯架 / Double tumbler holder  
材质: SUS 304  
工艺: 亮光  
箱容: 40



**KD-4315**  
皂碟 / Towel ring  
材质: SUS 304  
工艺: 亮光  
箱容: 40



**KD-4310**  
毛巾环 / Soap basket  
材质: SUS 304  
工艺: 亮光  
箱容: 40

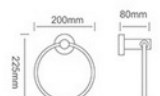



# 4300 series

缤纷生活 情趣盎然  
In roitous profusion life  
exuberant sentiment



**KD-4305**  
单层化妆台 / Glass shelf  
材质: SUS 304  
工艺: 亮光  
箱容: 15



**KD-4304**  
二层置物架 / Double layer glass shelf  
材质: SUS 304  
工艺: 亮光  
箱容: 10



**KD-4311**  
马桶刷 / Toilet brush  
材质: SUS 304  
工艺: 亮光  
箱容: 30

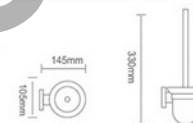

**KD-4303**  
单杆 / Towel bar  
材质: SUS 304  
工艺: 亮光  
箱容: 40

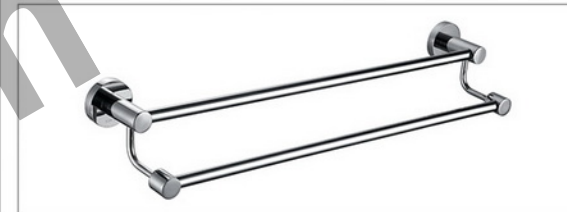

**KD-4302**  
高低杆 / Double towel bar  
材质: SUS 304  
工艺: 亮光  
箱容: 30



**KD-4301**  
浴巾架 / Double towel bar  
材质: SUS 304  
工艺: 亮光  
箱容: 15



**KD-4309**  
纸巾架 / Paper holder  
材质: SUS 304  
工艺: 亮光  
箱容: 40

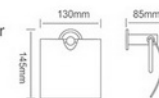

**KD-4300**  
浴巾架 / Towel shelf  
材质: SUS 304  
工艺: 亮光  
箱容: 15

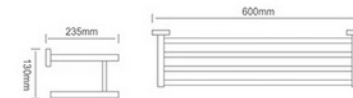





**SUS 304**  
**304 不锈钢**  
 不含铅、不含汞、不含砷

### 3900B series

永续创新，追求无止境  
 agelong innovation the  
 hankering is unending



**KD-3908B**  
 衣钩 / Clothes hood  
 材质：SUS 304  
 工艺：亮光  
 箱容：60



**KD-3912B**  
 皂网 / Soap dish  
 材质：SUS 304  
 工艺：亮光  
 箱容：40

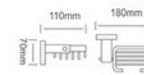

**KD-3906B**  
 单杯架 / Tumbler holder  
 材质：SUS 304  
 工艺：亮光  
 箱容：40



**KD-3913B**  
 双杯架 / Double tumbler holder  
 材质：SUS 304  
 工艺：亮光  
 箱容：40



**KD-3910B**  
 毛巾环 / Towel ring  
 材质：SUS 304  
 工艺：亮光  
 箱容：40

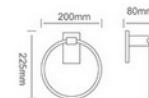

**KD-3915B**  
 皂碟 / Soap basket  
 材质：SUS 304  
 工艺：亮光  
 箱容：40







**KD3905B-1**  
 单层化妆台 / Glass shelf  
 材质: SUS 304  
 工艺: 亮光  
 箱容: 15



**KD-3905B-2**  
 单层化妆台 / Glass shelf  
 材质: SUS 304  
 工艺: 亮光  
 箱容: 15

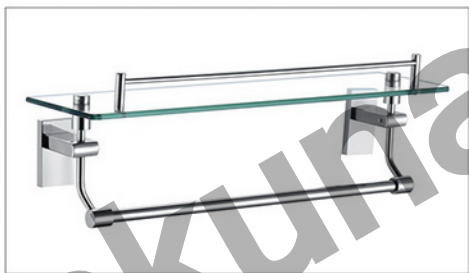

**KD-3903B-2**  
 二层置物架  
 Double layer glass shelf  
 材质: SUS 304  
 工艺: 亮光  
 箱容: 10

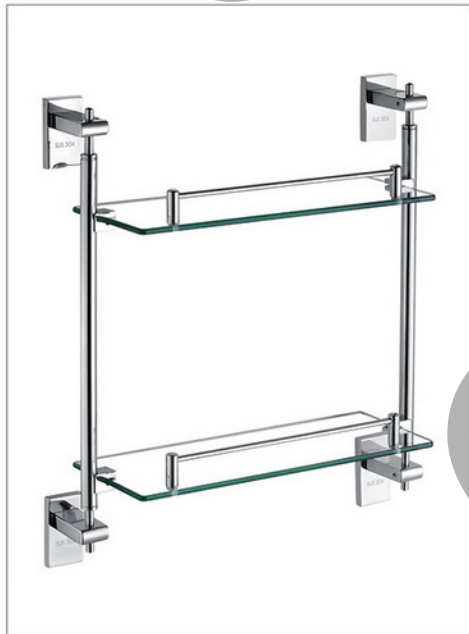
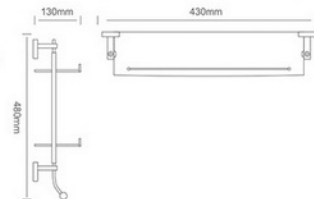

**KD-3903B-1**  
 二层置物架  
 Double layer glass shelf  
 材质: SUS 304  
 工艺: 亮光  
 箱容: 10

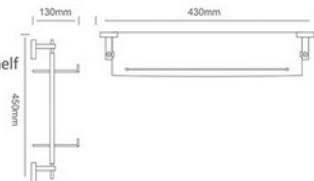

**KD-3911B**  
 马桶刷 / Toilet brush  
 材质: SUS 304  
 工艺: 亮光  
 箱容: 30

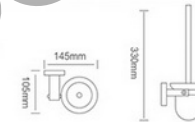

**KD-3902B**  
 单杆 / Towel bar  
 材质: SUS 304  
 工艺: 亮光  
 箱容: 40



**KD-3901B**  
 双杆 / Double towel bar  
 材质: SUS 304  
 工艺: 亮光  
 箱容: 30



## 3900B Series

永续创新, 追求无止境  
 aalong innovation the  
 hankering is unending



**KD-3909B**  
 纸巾架 / Paper holder  
 材质: SUS 304  
 工艺: 亮光  
 箱容: 40

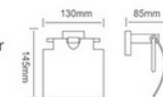

**KD-3900B**  
 浴巾架 / Towel shelf  
 材质: SUS 304  
 工艺: 亮光  
 箱容: 12

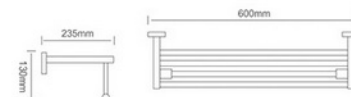



# 3500 series

前卫、新潮、个性品位  
Modern, fashion,  
individuated taste



## KD-3508

衣钩 / Clothes hood  
材质: SUS 304  
工艺: 亮光  
箱容: 60



## KD-3515

皂碟 / Soap dish  
材质: SUS 304  
工艺: 亮光  
箱容: 40



## KD-3506

单杯架 / Tumbler holder  
材质: SUS 304  
工艺: 亮光  
箱容: 40

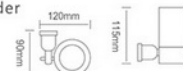

## KD-3513

双杯架 / Double tumbler holder  
材质: SUS 304  
工艺: 亮光  
箱容: 40



## KD-3510

毛巾环 / Towel ring  
材质: SUS 304  
工艺: 亮光  
箱容: 40

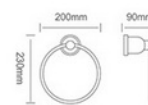

## KD-3512

皂网 / Soap basket  
材质: SUS 304  
工艺: 亮光  
箱容: 40

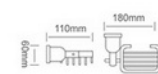



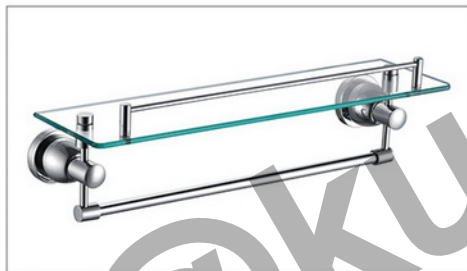

**KD-3505-1**

单层化妆台 / Glass shelf  
材质: SUS 304  
工艺: 亮光  
箱容: 15



**KD-3505-2**

单层化妆台 / Glass shelf  
材质: SUS 304  
工艺: 亮光  
箱容: 15

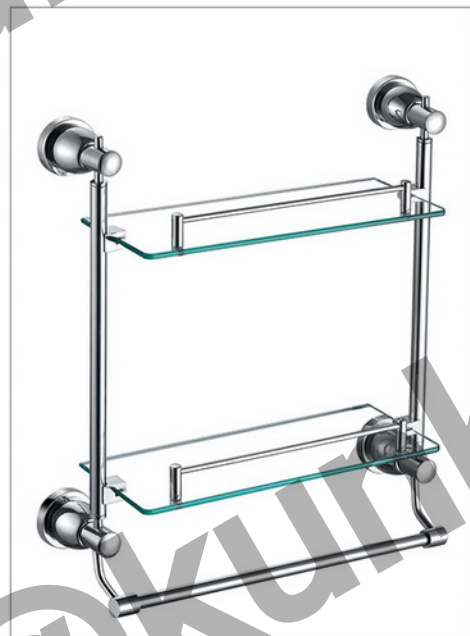

**KD-3503-2**

二层置物架  
Double layer glass shelf  
材质: SUS 304  
工艺: 亮光  
箱容: 10

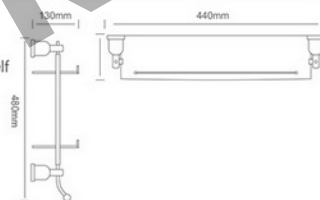

**KD-3503-1**

二层置物架  
Double layer glass shelf  
材质: SUS 304  
工艺: 亮光  
箱容: 10

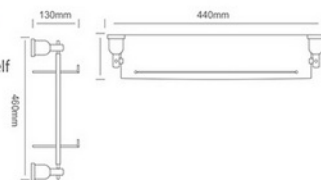

**KD-3511**

马桶刷 / Toilet brush  
材质: SUS 304  
工艺: 亮光  
箱容: 30

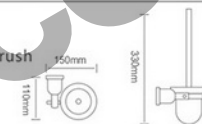

## 3500 series

前卫、新潮、个性品位  
Modern, fashion,  
individuated taste

**KD-3509**

纸巾架 / Paper holder  
材质: SUS 304  
工艺: 亮光  
箱容: 40

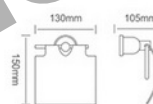

**KD-3502**

单杆 / Towel bar  
材质: SUS 304  
工艺: 亮光  
箱容: 40



**KD-3501**

双杆 / Double towel bar  
材质: SUS 304  
工艺: 亮光  
箱容: 30



**KD-3516**

高低杆 / Double towel bar  
材质: SUS 304  
工艺: 亮光  
箱容: 30



**KD-3500**

浴巾架 / Towel shelf  
材质: SUS 304  
工艺: 亮光  
箱容: 12

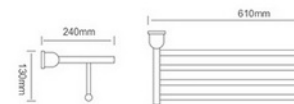



# 3400 series

艺术经典 灵感涌现  
artistic classical well  
up inspiration



**SUS 304**  
**爪锈钢**

不含铅·不生锈·不电镀



**KD-3408**

衣钩 / Clothes hood  
材质: SUS 304  
工艺: 亮光  
箱容: 60



**KD-3415**

皂碟 / Soap dish  
材质: SUS 304  
工艺: 亮光  
箱容: 40



**KD-3406**

单杯架 / Tumbler holder  
材质: SUS 304  
工艺: 亮光  
箱容: 40



**KD-3413**

双杯架 / Double tumbler holder  
材质: SUS 304  
工艺: 亮光  
箱容: 40



**KD-3410**

毛巾环 / Towel ring  
材质: SUS 304  
工艺: 亮光  
箱容: 40

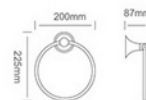

**KD-3412**

皂网 / Soap basket  
材质: SUS 304  
工艺: 亮光  
箱容: 40





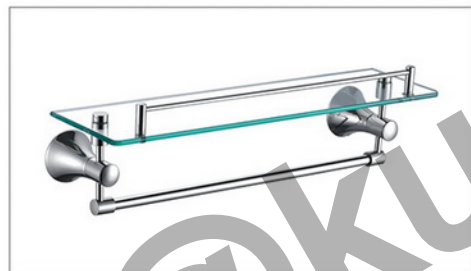

**KD-3405-1**

单层化妆台/Glass shelf  
材质: SUS 304  
工艺: 亮光  
箱容: 15



**KD-3405-2**

单层化妆台/Glass shelf  
材质: SUS 304  
工艺: 亮光  
箱容: 15

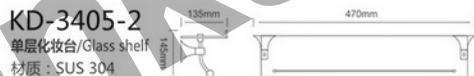

**KD-3403-2**

二层置物架  
Double layer glass shelf  
材质: SUS 304  
工艺: 亮光  
箱容: 10

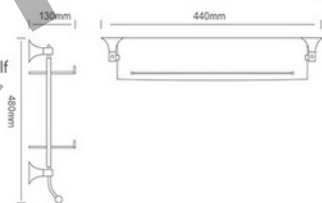

**KD-3403-1**

二层置物架  
Double layer glass shelf  
材质: SUS 304  
工艺: 亮光  
箱容: 10

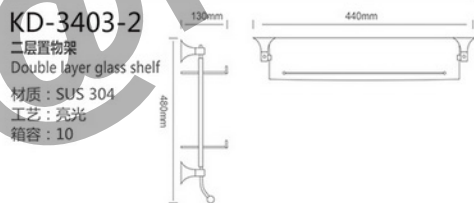
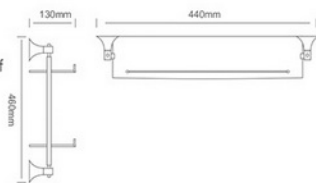

**KD-3411**

马桶刷 / Toilet brush  
材质: SUS 304  
工艺: 亮光  
箱容: 30

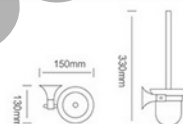

## 3400 series

艺术经典 灵感涌现  
artistic classical well  
up inspiration



**KD-3409**

纸巾架 / Paper holder  
材质: SUS 304  
工艺: 亮光  
箱容: 40

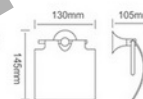

**KD-3402**

单杆 / Towel bar  
材质: SUS 304  
工艺: 亮光  
箱容: 40



**KD-3401**

双杆 / Double towel bar  
材质: SUS 304  
工艺: 亮光  
箱容: 30



**KD-3416**

高低杆 / Double towel bar  
材质: SUS 304  
工艺: 亮光  
箱容: 30



**KD-3400**

浴巾架 / Towel shelf  
材质: SUS 304  
工艺: 亮光  
箱容: 12







3600 series

品质卓越 值得信赖  
eximious quality is  
good for trust



**KD-3608**

衣钩 / Clothes hook  
材质: SUS 304  
工艺: 亮光  
箱容: 60



**KD-3615**

皂碟 / Soap dish  
材质: SUS 304  
工艺: 亮光  
箱容: 40



**KD-3606**

单杯架 / Tumbler holder  
材质: SUS 304  
工艺: 亮光  
箱容: 40



**KD-3613**

双杯架 / Double tumbler holder  
材质: SUS 304  
工艺: 亮光  
箱容: 40



**KD-3610**

毛巾环 / Towel ring  
材质: SUS 304  
工艺: 亮光  
箱容: 40

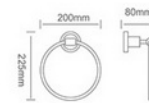

**KD-3612**

皂网 / Soap basket  
材质: SUS 304  
工艺: 亮光  
箱容: 40

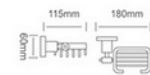



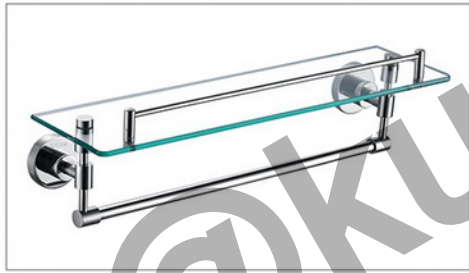

**KD-3605-1**  
 单层化妆台 / Glass shelf  
 材质: SUS 304  
 工艺: 亮光  
 箱容: 15



**KD-3605-2**  
 单层化妆台 / Glass shelf  
 材质: SUS 304  
 工艺: 亮光  
 箱容: 15

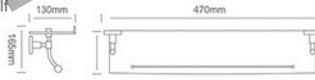
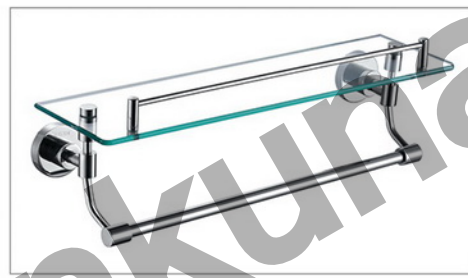

**KD-3603-1**  
 二层置物架  
 Double layer glass shelf  
 材质: SUS 304  
 工艺: 亮光  
 箱容: 10

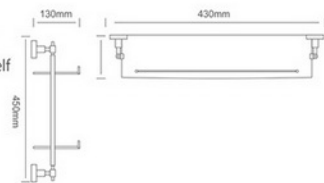

**KD-3603-2**  
 二层置物架  
 Double layer glass shelf  
 材质: SUS 304  
 工艺: 亮光  
 箱容: 10

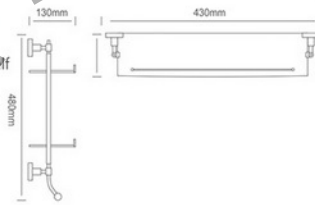

**KD-3611**  
 马桶刷 / Toilet brush  
 材质: SUS 304  
 工艺: 亮光  
 箱容: 30

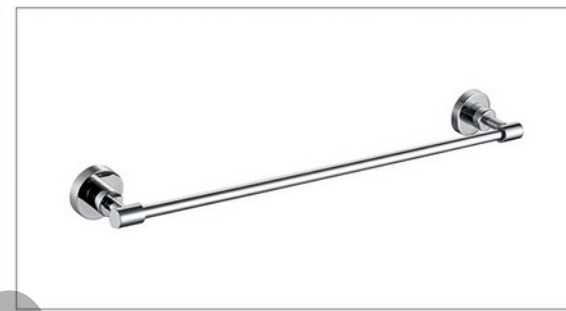
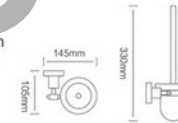

**KD-3602**  
 单杆 / Towel bar  
 材质: SUS 304  
 工艺: 亮光  
 箱容: 40



**KD-3601**  
 双杆 / Double towel bar  
 材质: SUS 304  
 工艺: 亮光  
 箱容: 30



## 3600 series

品质卓越 值得信赖  
 eximious quality is  
 good for trust



**KD-3609**  
 纸巾架 / Paper holder  
 材质: SUS 304  
 工艺: 亮光  
 箱容: 40

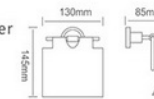

**KD-3600**  
 浴巾架 / Towel shelf  
 材质: SUS 304  
 工艺: 亮光  
 箱容: 12

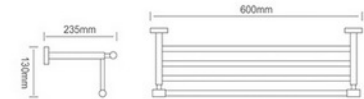



# HOOK Series

挂钩系列



Fashionable and simple, suitable for all kinds of decoration styles.

时尚简约，适合各类装修风格。



## JF-3301 方形挂钩

主要材质: SUS304不锈钢  
Main Material: SUS304 Stainless Steel  
规格尺寸: 45x45x2mm  
Sizes: 45x45x2mm  
表面处理: 砂光/镜光  
Surface Treatment: Sanding / Specular  
安装教程: 免打孔  
Installation Tutorial: No Punch

可选颜色:   
Optional Colors



## JF-3302 方形挂钩

主要材质: SUS304不锈钢  
Main Material: SUS304 Stainless Steel  
规格尺寸: 45x45x2mm  
Sizes: 45x45x2mm  
表面处理: 砂光/镜光  
Surface Treatment: Sanding / Specular  
安装教程: 免打孔  
Installation Tutorial: No Punch

可选颜色:   
Optional Colors



## JF-3303 方形挂钩

主要材质: SUS304不锈钢  
Main Material: SUS304 Stainless Steel  
规格尺寸: 45x45x2mm  
Sizes: 45x45x2mm  
表面处理: 砂光/镜光  
Surface Treatment: Sanding / Specular  
安装教程: 免打孔  
Installation Tutorial: No Punch

可选颜色:   
Optional Colors



## JF-801-1 方形挂钩

主要材质: SUS304不锈钢  
Main Material: SUS304 Stainless Steel  
规格尺寸: 60x30x2.5mm  
Sizes: 60x30x2.5mm  
表面处理: 拉丝/镜光  
Surface Treatment: Drawing / Specular  
安装教程: 打孔/免打孔  
Installation Tutorial: Punch / No Punch

可选颜色:   
Optional Colors



## JF-802-1 圆形挂钩

主要材质: SUS304不锈钢  
Main Material: SUS304 Stainless Steel  
规格尺寸: 60x30x2.5mm  
Sizes: 60x30x2.5mm  
表面处理: 拉丝/镜光  
Surface Treatment: Drawing / Specular  
安装教程: 打孔/免打孔  
Installation Tutorial: Punch / No Punch

可选颜色:   
Optional Colors



## JF-804-1 T形挂钩

主要材质: SUS304不锈钢  
Main Material: SUS304 Stainless Steel  
规格尺寸: 60x30x2.5mm  
Sizes: 60x30x2.5mm  
表面处理: 砂光/镜光  
Surface Treatment: Sanding / Specular  
安装教程: 打孔/免打孔  
Installation Tutorial: Punch / No Punch

可选颜色:   
Optional Colors



## JF-805 V形挂钩

主要材质: SUS304不锈钢  
Main Material: SUS304 Stainless Steel  
规格尺寸:  $\Phi 50 \times 60 \text{mm}$   
Sizes:  $\Phi 50 \times 60 \text{mm}$   
表面处理: 砂光/镜光  
Surface Treatment: Sanding / Specular  
安装教程: 打孔/免打孔  
Installation Tutorial: Punch / No Punch

可选颜色:   
Optional Colors



## JF-812 L形挂钩

主要材质: SUS304不锈钢  
Main Material: SUS304 Stainless Steel  
规格尺寸:  $\Phi 50 \times 10 \text{mm}$   
Sizes:  $\Phi 50 \times 10 \text{mm}$   
表面处理: 砂光/镜光  
Surface Treatment: Sanding / Specular  
安装教程: 打孔/免打孔  
Installation Tutorial: Punch / No Punch

可选颜色:   
Optional Colors



## JF-815 圆形挂钩

主要材质: SUS304不锈钢  
Main Material: SUS304 Stainless Steel  
规格尺寸: 80x5x20mm  
Sizes: 80x5x20mm  
表面处理: 砂光/镜光  
Surface Treatment: Sanding / Specular  
安装教程: 打孔/免打孔  
Installation Tutorial: Punch / No Punch

可选颜色:   
Optional Colors



## JF-803-1 衣帽钩

主要材质: SUS304不锈钢  
Main Material: SUS304 Stainless Steel  
规格尺寸: 60x30x2.5mm  
Sizes: 60x30x2.5mm  
表面处理: 砂光/镜光  
Surface Treatment: Sanding / Specular  
安装教程: 打孔/免打孔  
Installation Tutorial: Punch / No Punch

可选颜色:   
Optional Colors



## JF-3304 衣帽钩

主要材质: SUS304不锈钢  
Main Material: SUS304 Stainless Steel  
规格尺寸: 45x45x2mm  
Sizes: 45x45x2mm  
表面处理: 砂光/镜光  
Surface Treatment: Sanding / Specular  
安装教程: 免打孔  
Installation Tutorial: No Punch

可选颜色:   
Optional Colors



## JF-814 L型挂钩

主要材质: SUS304不锈钢  
Main Material: SUS304 Stainless Steel  
规格尺寸: 240x30x2.5mm  
Sizes: 240x30x2.5mm  
表面处理: 砂光/镜光  
Surface Treatment: Sanding / Specular  
安装教程: 打孔/免打孔  
Installation Tutorial: Punch / No Punch

可选颜色:   
Optional Colors



## JF-816 衣钩

主要材质: SUS304不锈钢  
Main Material: SUS304 Stainless Steel  
安装教程: 打孔螺丝  
Installation Tutorial: Punching Screw  
表面处理: 砂光/镜光  
Surface Treatment: Sanding / Specular  
可选颜色:   
Optional Colors



# HOOK Series

挂钩系列



## JF-806-5 | 圆形挂钩

主要材质: SUS304不锈钢  
Main Material: SUS304 Stainless Steel

表面处理: 砂光/镜光  
Surface Treatment: Sanding / Specular

可选颜色:  
Optional Colors

规格尺寸: 350X34X2.5mm  
Sizes: 350X34X2.5mm

安装教程: 打孔/免打孔  
Installation Tutorial: Punch / No Punch



## JF-802-5 | 圆形挂钩

主要材质: SUS304不锈钢  
Main Material: SUS304 Stainless Steel

表面处理: 砂光/镜光  
Surface Treatment: Sanding / Specular

可选颜色:  
Optional Colors

规格尺寸: 350x30x2.5mm  
Sizes: 350x30x2.5mm

安装教程: 打孔/免打孔  
Installation Tutorial: Punch / No Punch



## JF-803-6 | 衣帽钩

主要材质: SUS304不锈钢  
Main Material: SUS304 Stainless Steel

表面处理: 砂光/镜光  
Surface Treatment: Sanding / Specular

可选颜色:  
Optional Colors

规格尺寸: 430x30x2.5mm  
Sizes: 430x30x2.5mm

安装教程: 打孔/免打孔  
Installation Tutorial: Punch / No Punch



## JF-804-6 | L型挂钩

主要材质: SUS304不锈钢  
Main Material: SUS304 Stainless Steel

表面处理: 砂光/镜光  
Surface Treatment: Sanding / Specular

可选颜色:  
Optional Colors

规格尺寸: 430x30x2.5mm  
Sizes: 430x30x2.5mm

安装教程: 打孔/免打孔  
Installation Tutorial: Punch / No Punch





# HOOK — Series

挂钩系列

## JF-836 | 门后挂钩

主要材质: SUS304不锈钢  
Main Material: SUS304 Stainless Steel

表面处理: 拉丝/镜光  
Surface Treatment: Drawing / Specular

可选颜色:  
Optional Colors

规格尺寸: 430x300x45mm  
Sizes: 430x300x45mm

安装教程: 打孔螺丝  
Installation Tutorial: Punching Screw



## JF-807-6 | T形挂钩

主要材质: SUS304不锈钢  
Main Material: SUS304 Stainless Steel

表面处理: 砂光/镜光  
Surface Treatment: Sanding / Specular

可选颜色:  
Optional Colors

规格尺寸: 430x20x2.5mm  
Sizes: 430x20x2.5mm

安装教程: 打孔/免打孔  
Installation Tutorial: Punch / No Punch



## JF-809-6 | 圆形挂钩

主要材质: SUS304不锈钢  
Main Material: SUS304 Stainless Steel

表面处理: 砂光/镜光  
Surface Treatment: Sanding / Specular

可选颜色:  
Optional Colors

规格尺寸: 430x30x2mm  
Sizes: 430x30x2mm

安装教程: 打孔/免打孔  
Installation Tutorial: Punch / No Punch



## JF-810-60-10 | 活动型挂钩

主要材质: SUS304不锈钢  
Main Material: SUS304 Stainless Steel

表面处理: 砂光/镜光  
Surface Treatment: Sanding / Specular

可选颜色:  
Optional Colors

规格尺寸: 300-600mm  
Sizes: 300-600mm

安装教程: 打孔螺丝  
Installation Tutorial: Punching Screw



## JF-801-6 | 方形挂钩

主要材质: SUS304不锈钢  
Main Material: SUS304 Stainless Steel

表面处理: 拉丝/镜光  
Surface Treatment: Drawing / Specular

可选颜色:  
Optional Colors

规格尺寸: 430x30x2.5mm  
Sizes: 430x30x2.5mm

安装教程: 打孔螺丝  
Installation Tutorial: Punching Screw



# HOOK Series

## 挂钩系列

### JF-835 | 门后挂钩

主要材质: SUS304不锈钢  
Main Material: SUS304 Stainless Steel

规格尺寸: 300x150x45mm  
Sizes: 300x150x45mm

表面处理: 拉丝/镜光  
Surface Treatment: Drawing / Specular

安装教程: 打孔螺丝  
Installation Tutorial: Punching Screw

可选颜色:  
Optional Colors



### JF-811 | 单杆

主要材质: SUS304不锈钢  
Main Material: SUS304 Stainless Steel

规格尺寸:  $\Phi$ 50x80x600mm  
Sizes:  $\Phi$ 50x80x600mm

表面处理: 拉丝/镜光  
Surface Treatment: Drawing / Specular

安装教程: 打孔螺丝  
Installation Tutorial: Punching Screw

可选颜色:  
Optional Colors

### JF-833 | 刀架

主要材质: SUS304不锈钢  
Main Material: SUS304 Stainless Steel

规格尺寸: 320x60x30mm  
Sizes: 320x60x30mm

表面处理: 砂光/镜光  
Surface Treatment: Sanding / Specular

安装教程: 打孔螺丝  
Installation Tutorial: Punching Screw

可选颜色:  
Optional Colors



### JF-820-8 | 门后挂钩

主要材质: SUS304不锈钢  
Main Material: SUS304 Stainless Steel

规格尺寸: 630X110X20mm  
Sizes: 630X110X20mm

表面处理: 砂光/镜光  
Surface Treatment: Sanding / Specular

安装教程: 打孔螺丝  
Installation Tutorial: Punching Screw

可选颜色:  
Optional Colors



### JF-834 | 门后挂钩

主要材质: SUS304不锈钢  
Main Material: SUS304 Stainless Steel

规格尺寸: 450x220x45mm  
Sizes: 450x220x45mm

表面处理: 拉丝/镜光  
Surface Treatment: Drawing / Specular

安装教程: 打孔螺丝  
Installation Tutorial: Punching Screw

可选颜色:  
Optional Colors





# TOWEL

## — Rack Series

### 毛巾架系列



Simple Design, Strong Gravity Bearing  
简约设计，强承重力

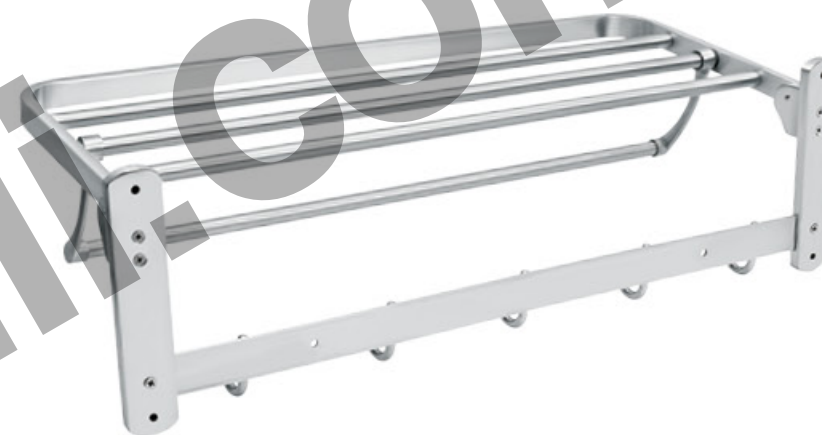

可选颜色：  
Optional Colors



#### JF-8612 | 活动型毛巾架

主要材质: SUS304不锈钢 | 表面处理: 拉丝/抛光 | 规格尺寸: 600x240x180mm | 安装教程: 打孔螺丝  
Main Material: SUS304 Stainless Steel | Surface Treatment: Drawing / Specular | Sizes: 600x240x180mm | Installation Tutorial: Punching Screw



可选颜色：  
Optional Colors



#### JF-8613 | 活动型毛巾架

主要材质: SUS304不锈钢 | 表面处理: 拉丝/抛光 | 规格尺寸: 600x240x180mm | 安装教程: 打孔螺丝  
Main Material: SUS304 Stainless Steel | Surface Treatment: Drawing / Specular | Sizes: 600x240x180mm | Installation Tutorial: Punching Screw





可选颜色:  
Optional Colors

**JF-8615** | 活动型毛巾架

主要材质: SUS304不锈钢 | 表面处理: 砂光/镜光 | 规格尺寸: 600x240x180mm | 安装教程: 打孔螺丝  
Main Material: SUS304 Stainless Steel | Surface Treatment: Sanding / Specular | Sizes: 600x240x180mm | Installation Tutorial: Punching Screw

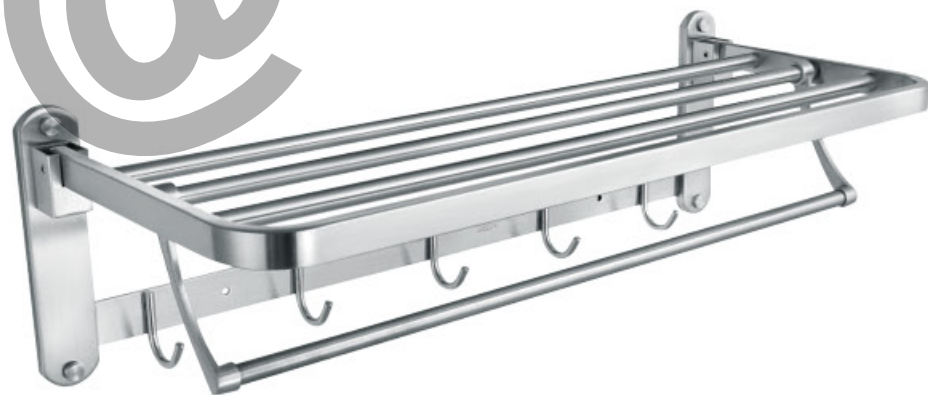

可选颜色:  
Optional Colors

**JF-8616** | 活动型毛巾架

主要材质: SUS304不锈钢 | 表面处理: 拉丝/镜光 | 规格尺寸: 600x240x180mm | 安装教程: 打孔螺丝  
Main Material: SUS304 Stainless Steel | Surface Treatment: Drawing / Specular | Sizes: 600x240x180mm | Installation Tutorial: Punching Screw



可选颜色:  
Optional Colors

**JF-8617** | 活动型毛巾架

主要材质: SUS304不锈钢 | 表面处理: 砂光/镜光 | 规格尺寸: 600x240x140mm | 安装教程: 打孔螺丝  
Main Material: SUS304 Stainless Steel | Surface Treatment: Sanding / Specular | Sizes: 600x240x140mm | Installation Tutorial: Punching Screw

# TOWEL — Rack Series 毛巾架系列



**JF-8623** | 活动型毛巾架(加杆)

主要材质: SUS304不锈钢  
Main Material: SUS304 Stainless Steel

规格尺寸: 600x240x140mm  
Sizes: 600x240x140mm

表面处理: 拉丝/镜光  
Surface Treatment: Drawing / Specular

安装教程: 打孔螺丝  
Installation Tutorial: Punching Screw

可选颜色:  
Optional Colors





可选颜色:  
Optional Colors



#### JF-8620 | 活动型毛巾架

主要材质: SUS304不锈钢 | 表面处理: 拉丝/镜光 | 规格尺寸: 620x260x160mm | 安装教程: 打孔螺丝  
Main Material: SUS304 Stainless Steel | Surface Treatment: Drawing / Specular | Sizes: 620x260x160mm | Installation Tutorial: Punching Screw



可选颜色:  
Optional Colors



#### JF-8621 | 活动型毛巾架

主要材质: SUS304不锈钢 | 表面处理: 砂光/镜光 | 规格尺寸: 600x240x180mm | 安装教程: 打孔螺丝  
Main Material: SUS304 Stainless Steel | Surface Treatment: Sanding / Specular | Sizes: 600x240x180mm | Installation Tutorial: Punching Screw

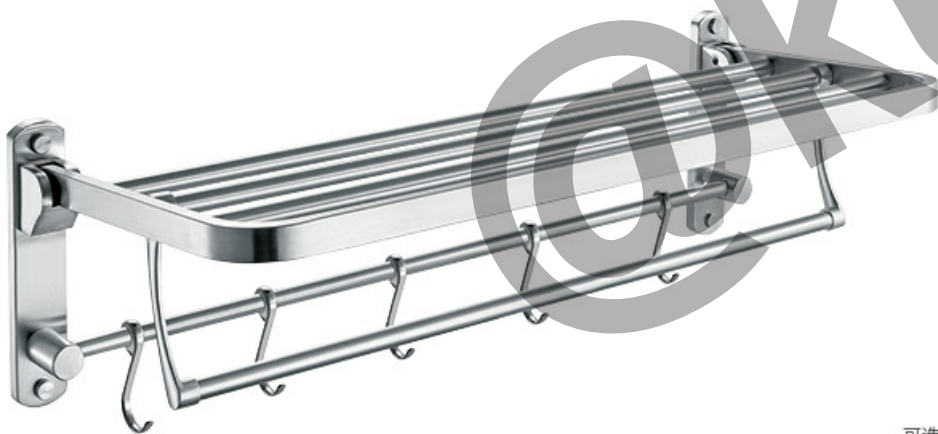

可选颜色:  
Optional Colors



#### JF-8629 | 活动型毛巾架

主要材质: SUS304不锈钢 | 表面处理: 拉丝/镜光 | 规格尺寸: 600x240x180mm | 安装教程: 打孔螺丝  
Main Material: SUS304 Stainless Steel | Surface Treatment: Drawing / Specular | Sizes: 600x240x180mm | Installation Tutorial: Punching Screw

# TOWEL — Rack Series 毛巾架系列



#### JF-8632 | 活动型毛巾架(加杆)

主要材质: SUS304不锈钢  
Main Material: SUS304 Stainless Steel

规格尺寸: 600x200x100mm  
Sizes: 600x200x100mm

表面处理: 拉丝/镜光  
Surface Treatment: Drawing / Specular

安装教程: 打孔螺丝  
Installation Tutorial: Punching Screw

可选颜色:  
Optional Colors





# TOWEL — Rack Series 毛巾架系列



可选颜色:  
Optional Colors ● ● ●

## JF-8633 | 毛巾架

主要材质: SUS304不锈钢  
Main Material: SUS304 Stainless Steel

表面处理: 喷黑  
Surface Treatment: Jet Black

规格尺寸: 400x55x20mm  
Sizes: 400x55x20mm

安装教程: 打孔螺丝  
Installation Tutorial: Punching Screw



可选颜色:  
Optional Colors ● ● ●

## JF-8601 | 活动型毛巾架

主要材质: SUS304不锈钢  
Main Material: SUS304 Stainless Steel

表面处理: 砂光/镜光  
Surface Treatment: Sanding / Specular

规格尺寸: 600x130x90mm  
Sizes: 600x130x90mm

安装教程: 打孔螺丝  
Installation Tutorial: Punching Screw



可选颜色:  
Optional Colors ● ● ●

## JF-8602 | 活动型毛巾架

主要材质: SUS304不锈钢  
Main Material: SUS304 Stainless Steel

表面处理: 砂光/镜光  
Surface Treatment: Sanding / Specular

规格尺寸: 600x200x90mm  
Sizes: 600x200x90mm

安装教程: 打孔螺丝  
Installation Tutorial: Punching Screw



可选颜色:  
Optional Colors ● ● ●

## JF-8605 | 活动型毛巾架

主要材质: SUS304不锈钢  
Main Material: SUS304 Stainless Steel

表面处理: 拉丝/镜光  
Surface Treatment: Drawing / Specular

规格尺寸: 600x60x60mm  
Sizes: 600x60x60mm

安装教程: 打孔螺丝  
Installation Tutorial: Punching Screw





# GROUND DRAG

## — Clip Series

地拖夹系列



### JF-808-2 | 方钩地拖夹

主要材质: SUS304不锈钢  
Main Material: SUS304 Stainless Steel

表面处理: 拉丝/镜光  
Surface Treatment: Drawing / Specular

可选颜色:  
Optional Colors



规格尺寸: 260x30x2mm  
Sizes: 260x30x2mm

安装教程: 打孔螺丝  
Installation Tutorial: Punching Screw



### JF-808-3 | 圆钩地拖夹

主要材质: SUS304不锈钢  
Main Material: SUS304 Stainless Steel

表面处理: 拉丝/镜光  
Surface Treatment: Drawing / Specular

可选颜色:  
Optional Colors



规格尺寸: 372x30x2mm  
Sizes: 372x30x2mm

安装教程: 打孔螺丝  
Installation Tutorial: Punching Screw

The Product Is Solid And Durable,  
Making Life More Convenient And Tidy After Use.

产品坚固耐用, 使用后让生活更方便整洁。





#### JF-830-40-6 | 活动型挂钩

主要材质: SUS304不锈钢  
Main Material: SUS304 Stainless Steel

表面处理: 喷黑  
Surface Treatment: Jet Black

规格尺寸: 400x50x30mm  
Sizes: 400x50x30mm

安装教程: 打孔螺丝  
Installation Tutorial: Punching Screw

可选颜色:  
Optional Colors ● ● ●



#### JF-3305 | 晾衣架

主要材质: SUS304不锈钢  
Main Material: SUS304 Stainless Steel

表面处理: 电镀  
Surface Treatment: Electroplate

规格尺寸: 720x400mm  
Sizes: 720x400mm

安装教程: 打孔螺丝  
Installation Tutorial: Punching Screw

可选颜色:  
Optional Colors ● ● ●

# SHELF

## Series

### 置物架系列

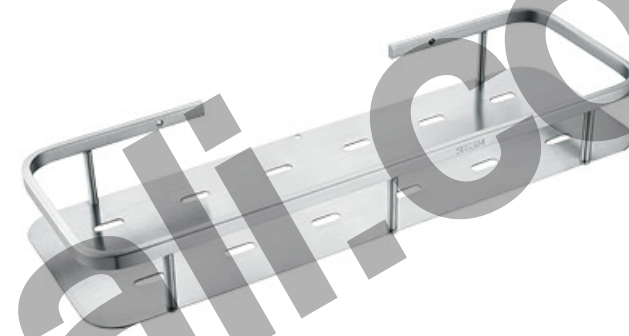

#### JF-8505 | 置物架

主要材质: SUS304不锈钢  
Main Material: SUS304 Stainless Steel

表面处理: 砂光/镜光  
Surface Treatment: Sanding / Specular

规格尺寸: 400x130x50mm  
Sizes: 400x130x50mm

安装教程: 打孔螺丝  
Installation Tutorial: Punching Screw

可选颜色:  
Optional Colors ● ● ●



#### JF-8507 | 置物架

主要材质: SUS304不锈钢  
Main Material: SUS304 Stainless Steel

表面处理: 砂光/镜光  
Surface Treatment: Sanding / Specular

规格尺寸: 500x120x35mm  
Sizes: 500x120x35mm

安装教程: 打孔螺丝  
Installation Tutorial: Punching Screw

可选颜色:  
Optional Colors ● ● ●



#### JF-8509 | 置物架

主要材质: SUS304不锈钢  
Main Material: SUS304 Stainless Steel

表面处理: 砂光/镜光  
Surface Treatment: Sanding / Specular

规格尺寸: 400x130x75mm  
Sizes: 400x130x75mm

安装教程: 打孔螺丝  
Installation Tutorial: Punching Screw

可选颜色:  
Optional Colors ● ● ●

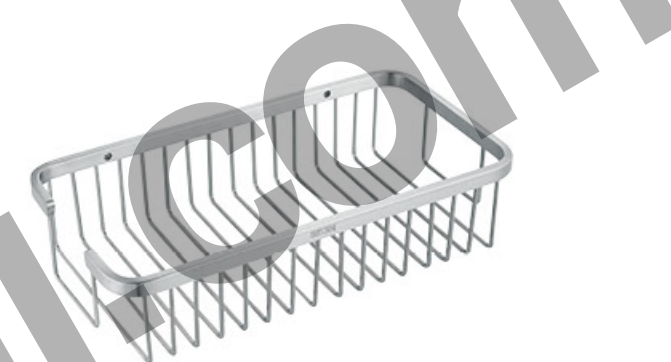

#### JF-8512 | 网篮

主要材质: SUS304不锈钢  
Main Material: SUS304 Stainless Steel

表面处理: 砂光/镜光  
Surface Treatment: Sanding / Specular

规格尺寸: 300x135x60mm  
Sizes: 300x135x60mm

安装教程: 打孔螺丝  
Installation Tutorial: Punching Screw

可选颜色:  
Optional Colors ● ● ●



# SHELF

## Series

### 置物架系列



JF-8501 | 置物架

主要材质: SUS304不锈钢  
Main Material: SUS304 Stainless Steel

规格尺寸: 250x250x50mm  
Sizes: 250x250x50mm

表面处理: 砂光/镜光  
Surface Treatment: Sanding / Specular

安装教程: 打孔螺丝  
Installation Tutorial: Punching Screw

可选颜色:  
Optional Colors



JF-8503 | 置物架

主要材质: SUS304不锈钢  
Main Material: SUS304 Stainless Steel

规格尺寸: 250x250x75mm  
Sizes: 250x250x75mm

表面处理: 拉丝/镜光  
Surface Treatment: Drawing / Specular

安装教程: 打孔螺丝  
Installation Tutorial: Punching Screw

可选颜色:  
Optional Colors



JF-8511 | 置物架

主要材质: SUS304不锈钢  
Main Material: SUS304 Stainless Steel

规格尺寸: 200x200x65mm  
Sizes: 200x200x65mm

表面处理: 砂光/镜光  
Surface Treatment: Sanding / Specular

安装教程: 打孔螺丝  
Installation Tutorial: Punching Screw

可选颜色:  
Optional Colors



JF-8502 | 置物架

主要材质: SUS304不锈钢  
Main Material: SUS304 Stainless Steel

规格尺寸: 250x250x50mm (总高300)  
Sizes: 250x250x50mm (Total Height 300)

表面处理: 砂光/镜光  
Surface Treatment: Sanding / Specular

安装教程: 打孔螺丝  
Installation Tutorial: Punching Screw

可选颜色:  
Optional Colors



JF-8504 | 置物架

主要材质: SUS304不锈钢  
Main Material: SUS304 Stainless Steel

规格尺寸: 250x250x75mm (总高380)  
Sizes: 250x250x75mm (Total Height 380)

表面处理: 砂光/镜光  
Surface Treatment: Sanding / Specular

安装教程: 打孔螺丝  
Installation Tutorial: Punching Screw

可选颜色:  
Optional Colors



JF-8506 | 置物架

主要材质: SUS304不锈钢  
Main Material: SUS304 Stainless Steel

规格尺寸: 400x130x50mm (总高380mm)  
Sizes: 400x130x50mm (Total Height 380mm)

表面处理: 砂光/镜光  
Surface Treatment: Sanding / Specular

安装教程: 打孔螺丝  
Installation Tutorial: Punching Screw

可选颜色:  
Optional Colors

Moisture Proof And Waterproof,  
Not Easy To Fall.  
No Space Limitation, More Convenient Storage.

防潮防水, 不易掉落。  
不受空间限制, 收纳更加省心。



# TISSUE — Box Series

## 纸巾盒系列



Multiple Choices, Moisture-Proof And Waterproof,  
Good Bearing Capacity

多款选择、防潮防水、承受力好



JF-CT-01 | 纸巾架

主要材质: 304不锈钢  
Main Material: 304 Stainless Steel  
规格尺寸: L120xW125xH123mm  
Sizes: L120xW125xH123mm  
表面处理: 砂光/镜光  
Surface Treatment: Sanding / Specular  
安装教程: 打孔螺丝  
Installation Tutorial: Punching Screw  
可选颜色:  
Optional Colors ● ● ●



JF-CT-03 | 纸巾架

主要材质: 304不锈钢  
Main Material: 304 Stainless Steel  
规格尺寸: L125xW130xH120mm  
Sizes: L125xW130xH120mm  
表面处理: 砂光/镜光  
Surface Treatment: Sanding / Specular  
安装教程: 打孔螺丝  
Installation Tutorial: Punching Screw  
可选颜色:  
Optional Colors ● ● ●



JF-CT-04 | 纸巾架

主要材质: 304不锈钢  
Main Material: 304 Stainless Steel  
规格尺寸: 170x28x3mm  
Sizes: 170x28x3mm  
表面处理: 砂光/镜光  
Surface Treatment: Sanding / Specular  
安装教程: 打孔螺丝  
Installation Tutorial: Punching Screw  
可选颜色:  
Optional Colors ● ● ●

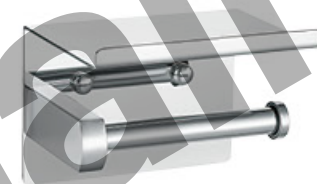

JF-CT-06 | 纸巾架

主要材质: 304不锈钢  
Main Material: 304 Stainless Steel  
规格尺寸: 138x100x95mm  
Sizes: 138x100x95mm  
表面处理: 砂光/镜光  
Surface Treatment: Sanding / Specular  
安装教程: 打孔螺丝  
Installation Tutorial: Punching Screw  
可选颜色:  
Optional Colors ● ● ●



JF-C7-07 | 纸巾盒

主要材质: 304不锈钢  
Main Material: 304 Stainless Steel  
规格尺寸: L180xW90xH80mm  
Sizes: L180xW90xH80mm  
表面处理: 砂光/镜光  
Surface Treatment: Sanding / Specular  
安装教程: 打孔螺丝  
Installation Tutorial: Punching Screw  
可选颜色:  
Optional Colors ● ● ●



JF-CT-05 | 纸巾架

主要材质: 304不锈钢  
Main Material: 304 Stainless Steel  
规格尺寸: L120xW123xH125mm  
Sizes: L120xW123xH125mm  
表面处理: 砂光/镜光  
Surface Treatment: Sanding / Specular  
安装教程: 打孔螺丝  
Installation Tutorial: Punching Screw  
可选颜色:  
Optional Colors ● ● ●



JF-CT-08 | 纸巾架

主要材质: 304不锈钢  
Main Material: 304 Stainless Steel  
规格尺寸: L260xW110xH110mm  
Sizes: L260xW110xH110mm  
表面处理: 砂光/镜光  
Surface Treatment: Sanding / Specular  
安装教程: 打孔螺丝  
Installation Tutorial: Punching Screw  
可选颜色:  
Optional Colors ● ● ●



JF-C7-09 | 纸巾盒

主要材质: 304不锈钢  
Main Material: 304 Stainless Steel  
表面处理: 砂光/镜光  
Surface Treatment: Sanding / Specular  
安装教程: 打孔螺丝  
Installation Tutorial: Punching Screw  
可选颜色:  
Optional Colors ● ● ●



JF-CT-20 | 马桶刷

主要材质: SUS304不锈钢  
Main Material: SUS304 Stainless Steel  
表面处理: 砂光/镜光  
Surface Treatment: Sanding / Specular  
安装教程: 打孔螺丝  
Installation Tutorial: Punching Screw  
可选颜色:  
Optional Colors ● ● ●



# Self-adhesive 自粘贴系列



WDS124  
挂钩 HOOK  
颜色: 银色/黑色



WDS124H  
挂钩 HOOK  
颜色: 银色/黑色



WDS124X  
挂钩 HOOK  
颜色: 银色/黑色



WDS124XH  
挂钩 HOOK  
颜色: 银色/黑色



WDS115X  
挂钩 HOOK  
颜色: 银色/黑色



WDS115XH  
挂钩 HOOK  
颜色: 银色/黑色



WDS115  
挂钩 HOOK  
颜色: 银色/黑色



WDS115H  
挂钩 HOOK  
颜色: 银色/黑色



WDS132  
挂钩 HOOK  
颜色: 银色/黑色



WDS132H  
挂钩 HOOK  
颜色: 银色/黑色



WDS301  
挂钩 HOOK  
颜色: 银色/黑色



WDS301H  
挂钩 HOOK  
颜色: 银色/黑色



Single Hook 单钩系列





# 自粘贴系列 Self-adhesive



WDS100  
挂钩 HOOK  
颜色: 银色/黑色



WDS100H  
挂钩 HOOK  
颜色: 银色/黑色



WDS102  
挂钩 HOOK  
颜色: 银色/黑色



WDS102H  
挂钩 HOOK  
颜色: 银色/黑色

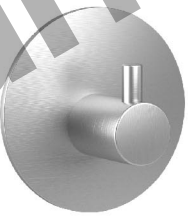

WDS102Y  
挂钩 HOOK  
颜色: 银色/黑色



WDS102YH  
挂钩 HOO  
颜色: 银色/黑色



WDS113  
挂钩 HOOK  
颜色: 银色/黑色



WDS113H  
挂钩 HOOK  
颜色: 银色/黑色



WDS113Y  
挂钩 HOOK  
颜色: 银色/黑色

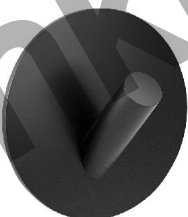

WDS113YH  
挂钩 HOOK  
颜色: 银色/黑色



WDS118  
挂钩 HOOK  
颜色: 银色/黑色



WDS118H  
挂钩 HOOK  
颜色: 银色/黑色



WDS118Y  
挂钩 HOOK  
颜色: 银色/黑色



WDS118YH  
挂钩 HOOK  
颜色: 银色/黑色



WDS136  
挂钩 HOOK  
颜色: 银色/黑色



WDS136H  
挂钩 HOOK  
颜色: 银色/黑色



# Self-adhesive 自粘贴系列



WDS136T  
挂钩 HOOK  
颜色: 银色/黑色

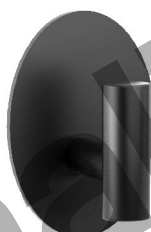

WDS136TH  
挂钩 HOOK  
颜色: 银色/黑色



WDS136Y  
挂钩 HOOK  
颜色: 银色/黑色



WDS136YH  
挂钩 HOOK  
颜色: 银色/黑色



WDS139G  
挂钩 HOOK  
颜色: 银色/黑色



WDS139GH  
挂钩 HOOK  
颜色: 银色/黑色



WDS139  
挂钩 HOOK  
颜色: 银色/黑色



WDS139H  
挂钩 HOOK  
颜色: 银色/黑色

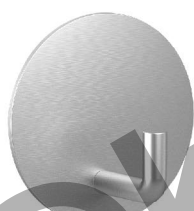

WDS139Y  
挂钩 HOOK  
颜色: 银色/黑色



WDS139YH  
挂钩 HOOK  
颜色: 银色/黑色



WDS142  
挂钩 HOOK  
颜色: 银色/黑色



WDS142H  
挂钩 HOOK  
颜色: 银色/黑色



WDS265  
挂钩 HOOK  
颜色: 银色/黑色



WDS265H  
挂钩 HOOK  
颜色: 银色/黑色



WDS251  
挂钩 HOOK  
颜色: 银色/黑色



WDS251H  
挂钩 HOOK  
颜色: 银色/黑色



自粘贴系列 Self-adhesive



WDS105  
挂钩 HOOK  
颜色: 银色/黑色



WDS105H  
挂钩 HOOK  
颜色: 银色/黑色

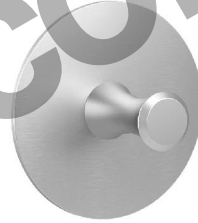

WDS251Y  
挂钩 HOOK  
颜色: 银色/黑色



WDS251YH  
挂钩 HOOK  
颜色: 银色/黑色



WDS329Y  
挂钩 HOOK  
颜色: 银色/黑色



WDS329H  
挂钩 HOOK  
颜色: 银色/黑色



WDS270  
挂钩 HOOK  
颜色: 银色/黑色



WDS270H  
挂钩 HOOK  
颜色: 银色/黑色



WDS214  
挂钩 HOOK  
颜色: 银色/黑色



WDS214H  
挂钩 HOOK  
颜色: 银色/黑色



WDS119  
挂钩 HOOK  
颜色: 银色/黑色



WDS119H  
挂钩 HOOK  
颜色: 银色/黑色



WDS137  
挂钩 HOOK  
颜色: 银色/黑色



WDS137H  
挂钩 HOOK  
颜色: 银色/黑色

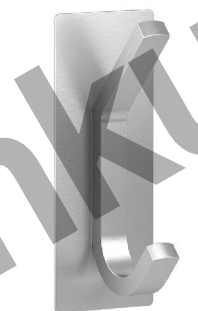

WDS137-30  
挂钩 HOOK  
颜色: 银色/黑色



WDS137-30H  
挂钩 HOOK  
颜色: 银色/黑色



# 打孔系列 Punch Series



**WDS245**  
挂钩 HOOK  
颜色: 银色/黑色

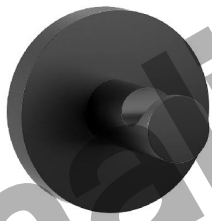

**WDS245H**  
挂钩 HOOK  
颜色: 银色/黑色

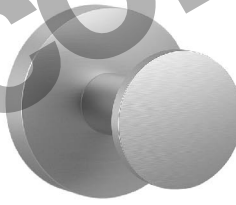

**WDS253**  
挂钩 HOOK  
颜色: 银色/黑色

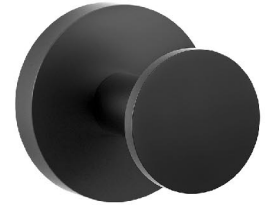

**WDS253H**  
挂钩 HOOK  
颜色: 银色/黑色

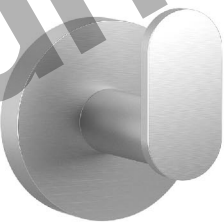

**WDS254**  
挂钩 HOOK  
颜色: 银色/黑色

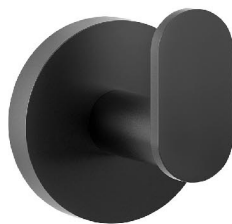

**WDS254H**  
挂钩 HOOK  
颜色: 银色/黑色

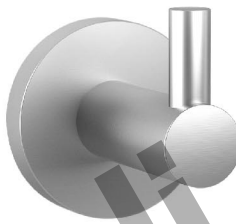

**WDS248**  
挂钩 HOOK  
颜色: 银色/黑色

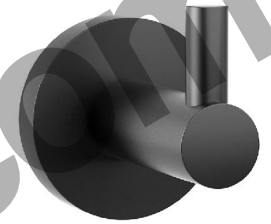

**WDS248H**  
挂钩 HOOK  
颜色: 银色/黑色

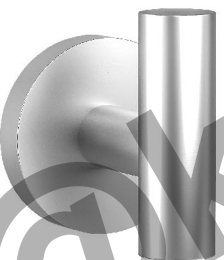

**WDS127-265**  
挂钩 HOOK  
颜色: 银色/黑色

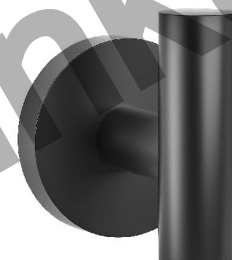

**WDS127-265H**  
挂钩 HOOK  
颜色: 银色/黑色



**WDS252**  
挂钩 HOOK  
颜色: 银色/黑色



**WDS252H**  
挂钩 HOOK  
颜色: 银色/黑色



**WDS256**  
挂钩 HOOK  
颜色: 银色/黑色

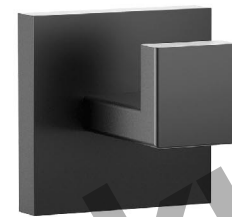

**WDS256H**  
挂钩 HOOK  
颜色: 银色/黑色

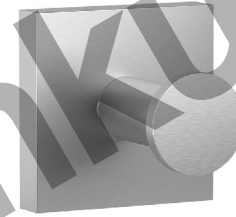

**WDS255**  
挂钩 HOOK  
颜色: 银色/黑色



**WDS255H**  
挂钩 HOOK  
颜色: 银色/黑色



# 打孔系列 Punch Series



WDS258  
纸巾架 Paper Holder  
颜色: 银色/黑色



WDS114  
纸巾架 Paper Holder  
颜色: 银色/黑色



WDS114H  
纸巾架 Paper Holder  
颜色: 银色/黑色



WDS258H  
纸巾架 Paper Hold  
颜色: 银色/黑色



WDS127-265  
纸巾架 Paper Holder  
颜色: 银色/黑色



WDS127-265H  
纸巾架 Paper Holder  
颜色: 银色/黑色



WDS145  
纸巾架 Paper Holder  
颜色: 银色/黑色



WDS145H  
纸巾架 Paper Holder  
颜色: 银色/黑色



纸巾架系列 Paper Holder





# Self-adhesive 自粘贴系列



**WDS131**  
纸巾架 Paper Holder  
颜色: 银色/黑色



**WDS131H**  
纸巾架 Paper Holder  
颜色: 银色/黑色

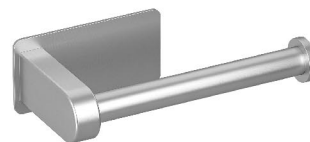

**WDS131Y**  
纸巾架 Paper Holder  
颜色: 银色/黑色

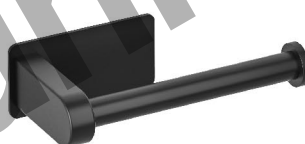

**WDS131YH**  
纸巾架 Paper Holder  
颜色: 银色/黑色

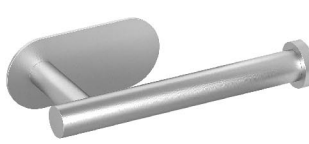

**WDS128**  
纸巾架 Paper Holder  
颜色: 银色/黑色



**WDS128H**  
纸巾架 Paper Holder  
颜色: 银色/黑色



**WDS233F**  
纸巾架 Paper Holder  
颜色: 银色/黑色

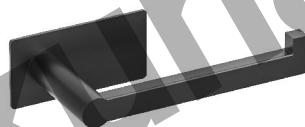

**WDS233FH**  
纸巾架 Paper Holder  
颜色: 银色/黑色

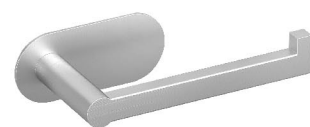

**WDS233Y**  
纸巾架 Paper Holder  
颜色: 银色/黑色

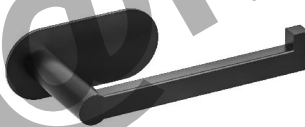

**WDS233YH**  
纸巾架 Paper Holder  
颜色: 银色/黑色



**WDS234**  
纸巾架 Paper Holder  
颜色: 银色/黑色



**WDS234H**  
纸巾架 Paper Holder  
颜色: 银色/黑色

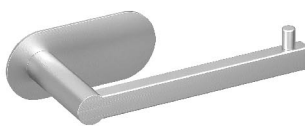

**WDS234Y**  
纸巾架 Paper Holder  
颜色: 银色/黑色



**WDS234YH**  
纸巾架 Paper Holder  
颜色: 银色/黑色

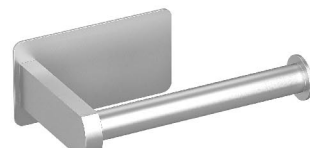

**WDS249**  
纸巾架 Paper Holder  
颜色: 银色/黑色



# 自粘贴系列 Self-adhesive



**WDS249H**  
纸巾架 Paper Holder  
颜色: 银色/黑色



**WDS131X**  
纸巾架 Paper Holder  
颜色: 银色/黑色



**WDS131XH**  
纸巾架 Paper Holder  
颜色: 银色/黑色



**WDS292**  
纸巾架 Paper Holder  
颜色: 银色/黑色



**WDS292H**  
纸巾架 Paper Holder  
颜色: 银色/黑色



**WDS278**  
纸巾架 Paper Holder  
颜色: 银色/黑色



**WDS278H**  
纸巾架 Paper Holder  
颜色: 银色/黑色

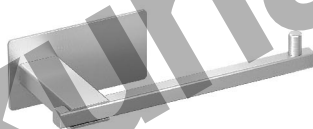

**WDS269**  
纸巾架 Paper Holder  
颜色: 银色/黑色



**WDS269H**  
纸巾架 Paper Holder  
颜色: 银色/黑色



**WDS138**  
纸巾架 Paper Holder  
颜色: 银色/黑色



**WDS138H**  
纸巾架 Paper Holder  
颜色: 银色/黑色



**WDS250**  
纸巾架 Paper Holder  
颜色: 银色/黑色



**WDS250H**  
纸巾架 Paper Holder  
颜色: 银色/黑色



**WDS284**  
纸巾架 Paper Holder  
颜色: 银色/黑色



**WDS284H**  
纸巾架 Paper Holder  
颜色: 银色/黑色



# Self-adhesive 自粘贴系列

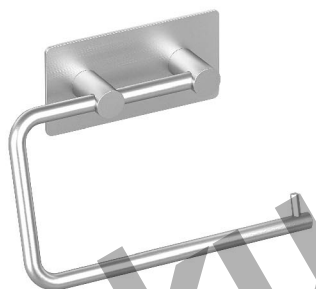

WDS104  
纸巾架 Paper Holder  
颜色: 银色/黑色

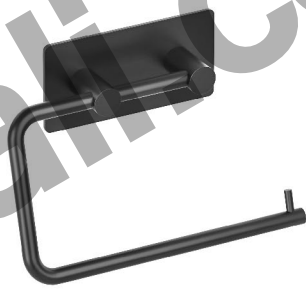

WDS104H  
纸巾架 Paper Holder  
颜色: 银色/黑色

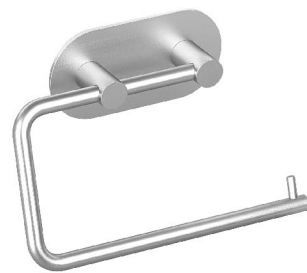

WDS104T  
纸巾架 Paper Holder  
颜色: 银色/黑色



WDS104TH  
纸巾架 Paper Holder  
颜色: 银色/黑色

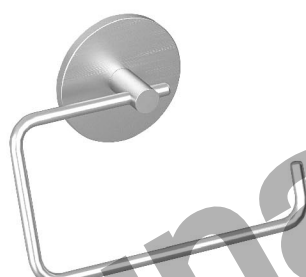

WDS193  
纸巾架 Paper Holder  
颜色: 银色/黑色



WDS193H  
纸巾架 Paper Holder  
颜色: 银色/黑色



WDS149  
纸巾架 Paper Holder  
颜色: 银色/黑色



WDS149H  
纸巾架 Paper Holder  
颜色: 银色/黑色



WDS129  
纸巾架 Paper Holder  
颜色: 银色/黑色



# 纸巾架系列 Paper Holder



WDS129H  
纸巾架 Paper Holder  
颜色: 银色/黑色



WDS250C  
纸巾架 Paper Holder  
颜色: 银色/黑色



WDS250CH  
纸巾架 Paper Holder  
颜色: 银色/黑色



WDS149C  
纸巾架 Paper Holder  
颜色: 银色/黑色



WDS138C  
纸巾架 Paper Holder  
颜色: 银色/黑色



WDS138CH  
纸巾架 Paper Holder  
颜色: 银色/黑色



WDS149CH  
纸巾架 Paper Holder  
颜色: 银色/黑色

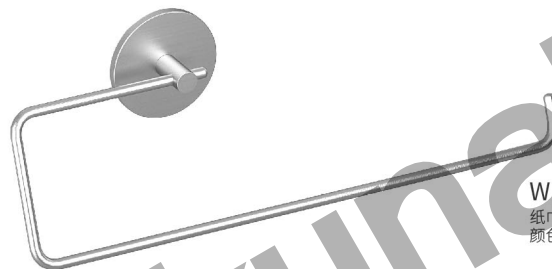

WDS193C  
纸巾架 Paper Holder  
颜色: 银色/黑色

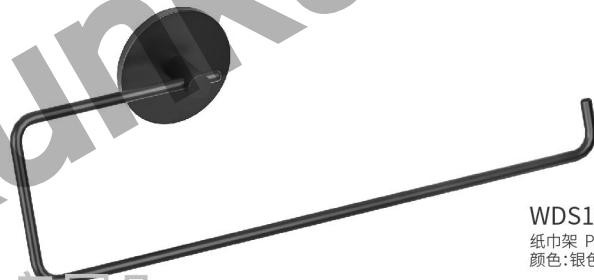

WDS193CH  
纸巾架 Paper Holder  
颜色: 银色/黑色



# Punch Series 打孔系列

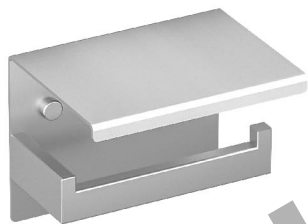

**WDS123**  
纸巾架 Paper Holder  
颜色: 银色/黑色

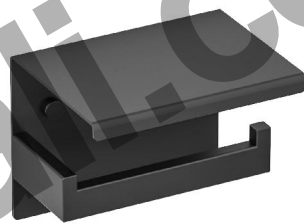

**WDS123H**  
纸巾架 Paper Holder  
颜色: 银色/黑色

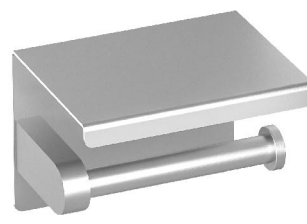

**WDS143**  
纸巾架 Paper Holder  
颜色: 银色/黑色

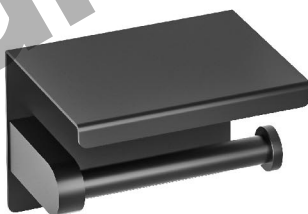

**WDS143H**  
纸巾架 Paper Holder  
颜色: 银色/黑色



**WDS274**  
纸巾架 Paper Holder  
颜色: 银色/黑色



**WDS274H**  
纸巾架 Paper Holder  
颜色: 银色/黑色

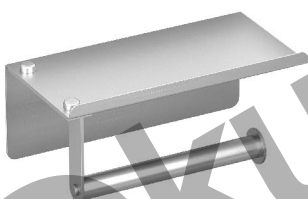

**WDS259Y**  
纸巾架 Paper Holder  
颜色: 银色/黑色



**WDS259YH**  
纸巾架 Paper Holder  
颜色: 银色/黑色



**WDS151**  
纸巾架 Paper Holder  
颜色: 银色/黑色



**WDS151H**  
纸巾架 Paper Holder  
颜色: 银色/黑色

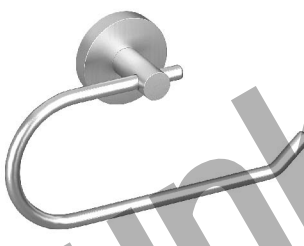

**WDS236**  
纸巾架 Paper Holder  
颜色: 银色/黑色



**WDS236H**  
纸巾架 Paper Holder  
颜色: 银色/黑色